



Model Number:
SG-TTW-14HC

Electronic Through the Wall Air Conditioner Operating Instructions



V.130320

Thank you for choosing a Soleus Air powered by Gree Air Conditioner. This owner's manual will provide you with valuable information necessary for the proper care and maintenance of your new product. Please take a few moments to thoroughly read the instructions and familiarize yourself with all the operational aspects of your new air conditioner.

For your own records, please attach a copy of your sales receipt to this manual. Also, write the store name/location, date purchased, and serial number below:

Store Name: _____

Location: _____

Date Purchased: _____

Serial Number (located on back of unit): _____

IMPORTANT SAFETY INSTRUCTIONS

Before installing and using your air conditioner, please read this owner's manual carefully. Store this manual in a safe place for future reference. Your safety and the safety of others is very important to us. Please pay attention to all safety messages outlined in this owner's manual.

WARNING: To reduce the risk of fire, electrical shock or injury when using your air conditioner, follow the following basic precautions:

- | | |
|---|--|
| <ul style="list-style-type: none">• Plug into a grounded 3 prong outlet.• Do not remove the ground prong.• Do not use a plug adapter. | <ul style="list-style-type: none">• Do not use an extension cord.• Unplug the air conditioner before servicing• Use two or more people to move and install the air conditioner |
|---|--|



This is a safety alert symbol.
This symbol alerts you to potential hazards that can harm you or others or even cause death.
All safety messages will directly follow the safety alert symbol and/or the words "DANGER" or "WARNING".

⚠ DANGER

⚠ WARNING

Failure to immediately follow these instructions may cause serious injury or even death.

All Safety messages alert you of potential hazards, how to reduce the chance of injury, and what can happen if instructions are not followed correctly.

ELECTRICAL REQUIREMENTS

⚠ WARNING



Electrical Shock Hazard

Plug into a grounded 3 prong outlet.
Do not remove the ground prong.
Do not use an adapter
Do not use an extension cord.
Failure to follow these instructions can result in death, fire, or electrical shock

The electrical ratings for your air conditioner are listed on the model and serial number label located on the front left side of the unit (when facing the front).

Specific electrical requirements are listed in the chart below. Follow the requirements below for the type of plug on the power supply cord.

Power Supply Cord

NEMA 6-20P

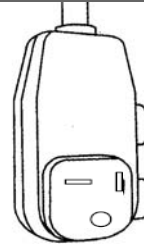

Recommended Ground Method

For your personal safety, this air conditioner must be grounded. This air conditioner is equipped with a 3 prong power supply cord with a grounded plug. To minimize the possibility of electrical shock, the cord must be plugged into a 3 prong outlet and grounded in accordance with all local codes and ordinances. If a 3 prong outlet is not available, it is the customer's responsibility to have a properly grounded 3 prong outlet installed by a qualified electrician.

It is the customer's responsibility:

- To contact a qualified electrician
- To assure that the electrical installation is adequate and in conformance with the National Electrical Code, ANSI/NFPA 70 - latest edition, and all local codes and ordinances.

Copies of the standards listed may be obtained from:

National Fire Protection Association

One Batterymarch Park

Quincy, Massachusetts 02269

LCDI Power Cord and Plug - NEMA 6-20P

This air conditioner is equipped with an LCDI (Leakage Current Detection and Interruption) power cord and plug as required by US National Electric Code 440.65. This cord consists of a length of shielded flexible cord with no termination on the load side and a LCDI attachment plug on the line side.

The LCDI power cord and plug will remove the supply source via electrical disconnect (circuit trip) if the nominal current leakage between the cord shield and either load conductor exceeds a predetermined value. The cord will remain de-energized until the device has been manually reset. This is intended to reduce the risk of a fire in the power cord or combustible materials nearby. The cord shields are not grounded and they must be considered a shock hazards if exposed. The cord shield must not be connected to ground or to any exposed metal.

The test and reset buttons on the LCDI Plug are used to check if the plug is functioning properly. To test the plug:

1. Plug power cord into a wall outlet, the power light will turn on.
2. Press the TEST Button, the circuit should trip and cut all power to the air conditioner. The power light will turn off.
3. Press the RESET button for use. The power light will turn back on.

If a test is performed and the indicator light remains ON prior to pressing RESET, current leakage has been detected. Do not use the air conditioner or attempt to reset the LCDI Plug. Contact Customer Service for troubleshooting recommendations.

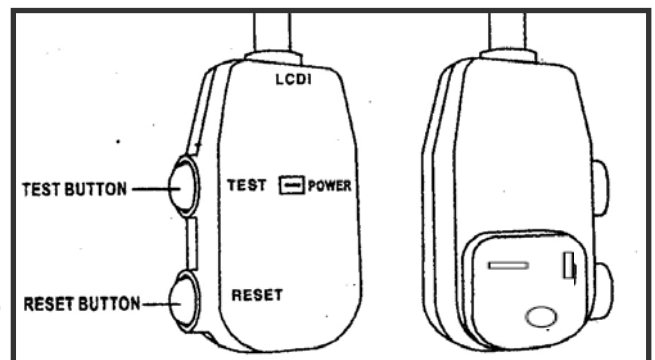

IMPORTANT SAFETY INSTRUCTIONS

Read all instructions before using this air conditioner

FOR YOUR SAFETY

Do not store or use gasoline or other flammable vapors and liquids in the vicinity of this or any other appliance. Read product labels for flammability and other warnings.

ACCIDENT PREVENTION

To reduce the risk of fire, electrical shock, or injury to persons when using your air conditioner, follow basic precautions, including the following:

- Be sure the electrical service is adequate for the model you have chosen. This information can be found on the serial number plate located on the side of the cabinet or behind the grille.
- If the air conditioner is to be installed in a window, you will probably want to clean both sides of the glass prior to installation. If the window is a triple-track type with a screen panel included, remove the screen completely before installation.
- Be sure the air conditioner has been securely and correctly installed according to the installation instructions provided with this manual. Save this manual and the installation instructions for future use when removing and reinstalling the unit.
- When handling the air conditioner, be careful to avoid cuts from sharp metal fins on the front and rear coils.

DISCLAIMER

ALL INFORMATION AND THE TECHNICAL SPECIFICATIONS PRESENTED IN THIS USER'S MANUAL ARE THE PRESENTATION OF THE MANUFACTURER. SOLEUS INTERNATIONAL HAS NOT CONDUCTED INDEPENDENT TEST TO THE INFORMATION AND THE SPECIFICATIONS PRESENTED HEREWITHIN.

SPECIFICATIONS

- Noise level is measured at a distance of 3.28 ft away from the front of the unit in cooling mode.
- Power consumption is measured when the fan runs at the highest speed setting.
- These specifications are for reference only. For actual data, please refer to the rating label on the unit.

Model	SG-TTW-14HC
Power Supply (Ph/V/Hz)	1/230-208/60
Dehumidifier Capacity (Pints/Day)	100
Rated Cooling Capacity (BTU/Hr)	14,000/13,600
Rated Heating Capacity (BTU/Hr)	10,600/8,600
Cooling Power Input (Watts)	1,650/1,600
Heating Power Input (Watts)	3,450/2,800
Rated Current Cooling (Amperage)	7.0/7.5
Rated Current Heating (Amperage)	15/13.6
EER (Cooling)	8.5
Noise Level Indoor/Outdoor [dB(A)]	59/70
Air Flow (CFM)	320
Product Dimensions WxDxH (Inches)	24 x 20.625 x 14.5
Product Weight (LBS)	84
Refrigerant	R-410A

NORMAL OPERATING SOUNDS

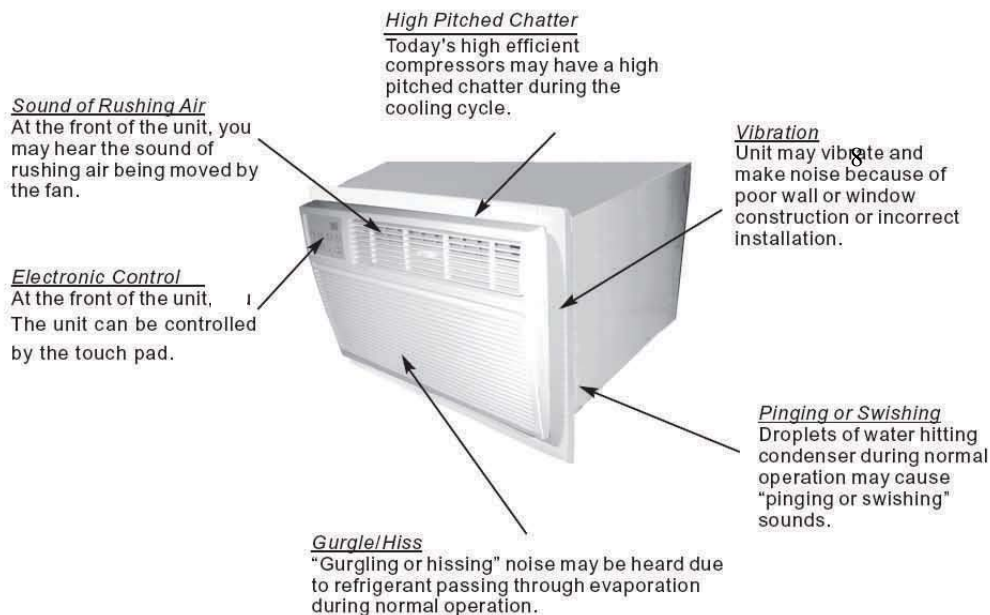

OPERATING YOUR AIR CONDITIONER

Before you start using your air conditioner, please familiarize yourself with the control panel and remote control the functions of each. This air conditioner can be controlled by the control panel (touch pad) or the included remote control.

CONTROL PANEL (TOUCH PAD for cool only model)

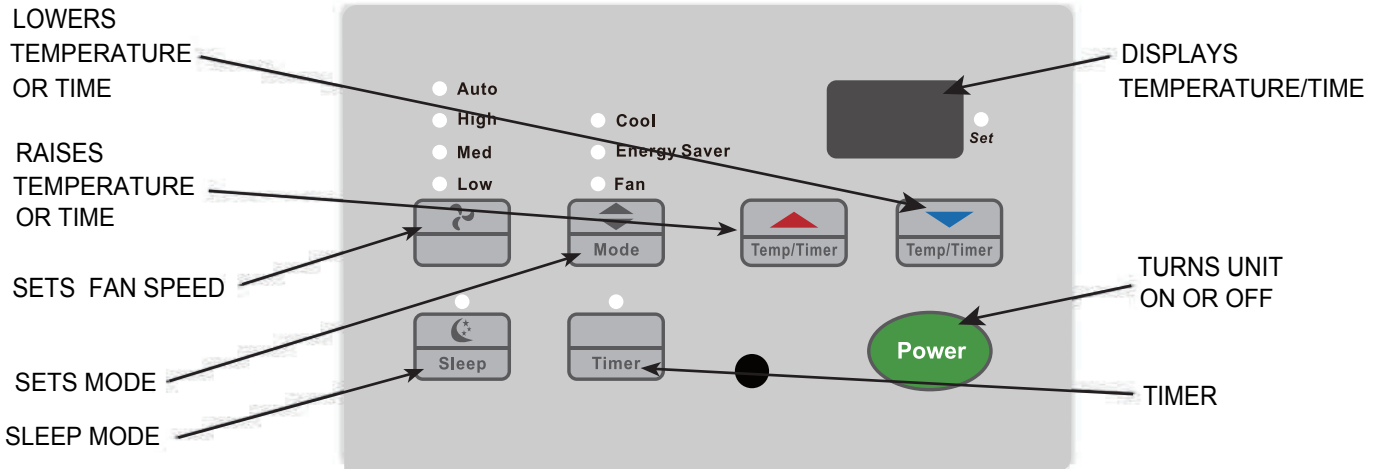

CONTROL PANEL (TOUCH PAD for cool and heat model)

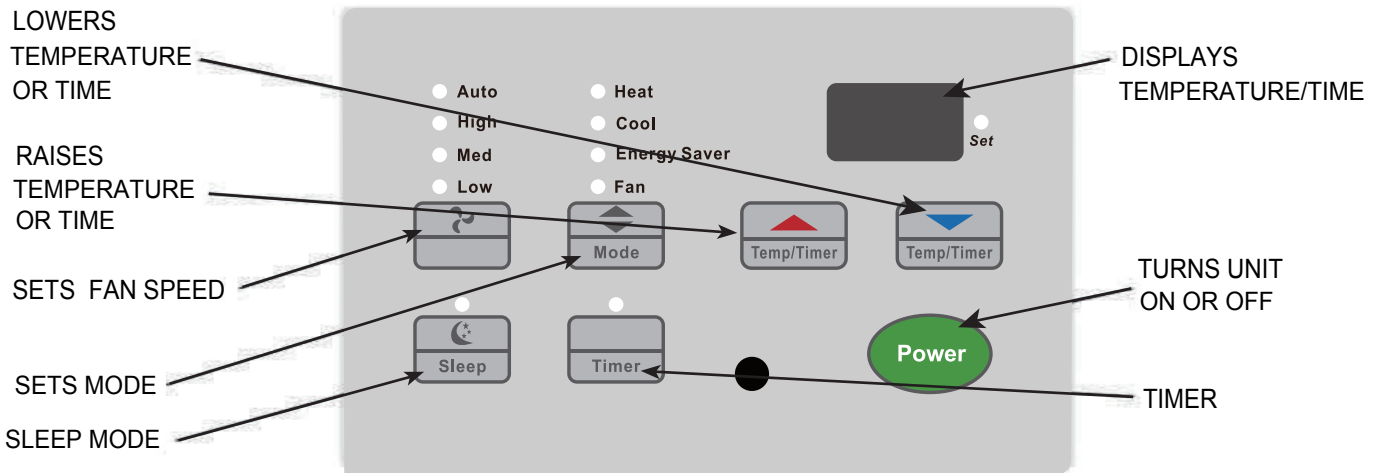

◆ Air Conditioner Features(continued)

Note: Be sure that there are no obstructions between receiver and remote controller; Don't drop or throw the remote control; Don't let any liquid in the remote control and put the remote control directly under the sunlight or any place where is very hot.

Signal transmitter



Remote control

ON/OFF

ON/OFF button

- Press this button, the unit will be turned on, press it once more, the unit will be turned off. When turning on or turning off the unit, the Timer, Sleep function will be canceled, but the presetting time is still remained.

MODE

MODE button

- Press this button, Auto, Cool, Save(Energy Saver), Fan, Heat mode can be selected circularly. Auto mode is default while power on. Under Auto mode, the temperature will not be displayed; Under Heat mode, the initial value is 28 °C (82°F); Under other modes, the initial value is 25 °C (77°F) .

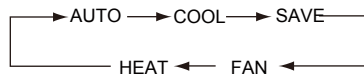

- AUTO
- COOL
- SAVE
- FAN
- HEAT

(Auto mode is not available on this model)

SLEEP

SLEEP button

- Press this button, Sleep On and Sleep Off can be selected. After powered on, Sleep Off is defaulted. After the unit is turned off, the Sleep function is canceled. After Sleep function set up, the signal of Sleep will display. In this mode, the time of timer can be adjusted. Under Fan and Auto modes, this function is not available.

FAN

FAN button

- By pressing this key, you may select AUTO, FAN 1, FAN 2, FAN 3 or FAN 4, and may also cycle between them. FAN 4 only in cool, save and heat mode. After being energized, AUTO is defaulted.

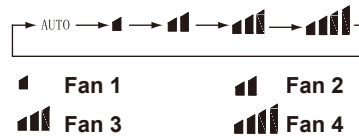

- Fan 1
- Fan 2
- Fan 3
- Fan 4

(Fan 4 is not available on this model)

SWING

SWING button

- Press this key to activate or deactivate the swing.

(Swing Mode is not available on this model)

◆ Air Conditioner Features(continued)

Notice: This is a general use remote controller, it could be used for the air conditioners with multifunction; For some function, which the model doesn't have, if press the corresponding button on the remote controller that the unit will keep the original running status.

Remote control



TIMER

TIMER button

- By pressing this key under switch-off state, you may set the time for auto switch-on. The range of setting is 0.5 ~ 24 hours. The characters "T-ON" and "H" will flash for 5 seconds. Within 5 seconds, you may make one press of this key to complete the setting and send the message. If the setting is valid, the set time will be displayed for 2 seconds before display of the temperature message. During flash, you may press "+" key to increase the value and press "-" key to decrease the value. The time will increase or decrease by 0.5 hours with each press of this key. If pressing "+" or "-" key continuously, the time value will change rapidly. The remote controller can increase the set time by 0.5 hours every 0.25 seconds. After being energized, the fault is no timer setting, and there is no display of "T-ON" or "H". Press ON/OFF key to switch on the unit and cancel the auto switch-on. When the temperature display becomes constant, you may press this key again to display the remaining set time. The time value, "T-On" and "H" will display constantly for 2 seconds. After 2 seconds, the preset temperature will be displayed. Within these 2 seconds, you may press this key again to cancel the auto switch-on and send the message.
- By pressing this key under switch-on state, you may set the time for auto switch-off. The method of setting as the same as for auto switch-on.

+ button

- For presetting temperature increasing. Press this button, can set up the temperature, when unit is on. Continuously press and hold this button for more than 2 seconds, the corresponding contents will be changed rapidly, until unpress the button then send the information, °C(°F) is displaying all along. In Auto mode, the temperature can not be set up, but operate this button can send the signal. Centigrade setting range :16-30; Fahrenheit scale setting range 61-86.

- button

- Presetting temperature can be decreased. Press this button, the temperature can be set up, continuously press this button and hold for two seconds, the relative contents can quickly change, until unhold this button and send the order that the °C (°F) signal will be displayed all the time. The temperature adjustment is unavailable under the Auto mode, but the order can be sent by if pressing this button.

◆ Air Conditioner Features(continued)

Guide for operation- General operation

1. After powered on, press ON/OFF button, the unit will start to run.(Note: When it is powered off, the guide louver of main unit will close automatically.)
2. Press MODE button, select desired running mode, or press COOL or HEAT mode to enter into the corresponding operation directly.
3. Pressing + or - button, to set the desired temperature. (It is unnecessary to set the temp. at AUTO mode.)
4. Pressing FAN button, set fan speed, can select AUTO, FAN 1, FAN 2, FAN 3 or FAN 4.
5. Pressing SWING button, to select the swing.

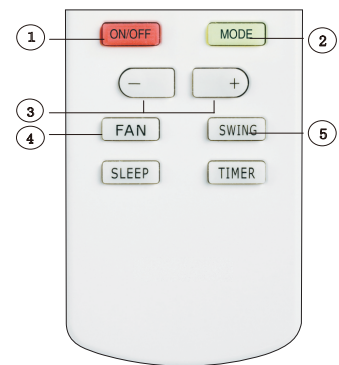

Guide for operation- Optional operation

1. Press SLEEP button, to set sleep.
2. Press TIMER button, can set the scheduled timer on or timer off.

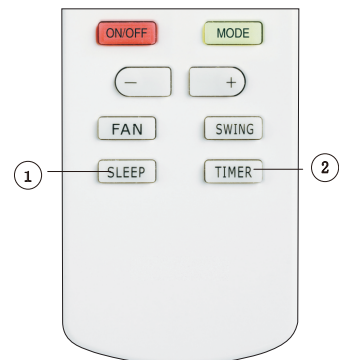

Introduction for special function

★ About AUTO RUN

When AUTO RUN mode is selected, the setting temperature will not be displayed on the LCD, the unit will be in accordance with the room temp. automatically to select the suitable running method and to make ambient comfortable.

★ About LOCK

Under switch-on or switch-off state, you may hold "+" and "-" key simultaneously to lock and unlock the keypad. When locked, the display will show the LOCK icon, in which case the lock icon will flash three times upon operation of any key. After the keypad is unlocked, the lock icon on the display will be hidden. After being energized, the default is unlock.

★ About switch between Fahrenheit and Centigrade

Under switch-off state, you may hold "-" and "MODE" keys simultaneously to switch between °C and °F.

Changing batteries and notices

1. Slightly to press the place  to take out the back cover of wireless remote control.(As shown in figure)
2. Take out the old batteries. (As show in figure)
3. Insert two new AAA1.5V dry batteries, and pay attention to the polarity. (As show in figure)
4. Attach the back cover of wireless remote control. (As show in figure)

★ NOTE:

- When changing the batteries, do not use the old or different batteries, otherwise, it can cause the malfunction of the wireless remote control.
- If the wireless remote control will not be used for a long time, please take them out, and don't let the leakage liquid damage the wireless remote control.
- The operation should be in its receiving range.
- It should be placed at where is 1m away from the TV set or stereo sound sets.
- If the wireless remote control can not operate normally, please take them out, after 30s later and reinsert, if they cannot normally run, please change them.

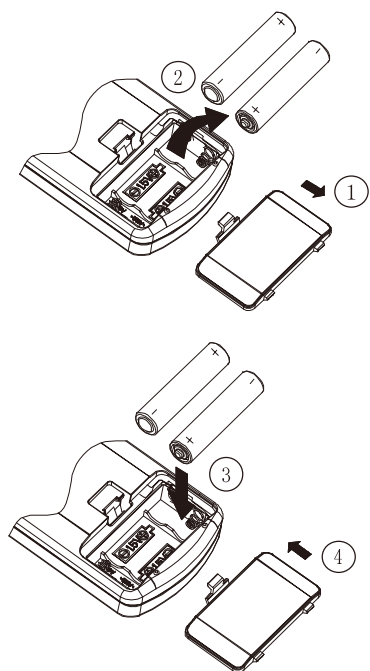

◆ Air Conditioner Features(continued)

TO TURN UNIT ON:

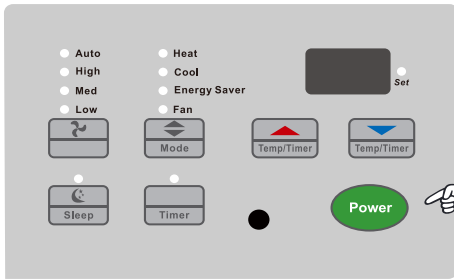

DO THIS:
PRESS ON/OFF
BUTTON

YOU WILL SEE:

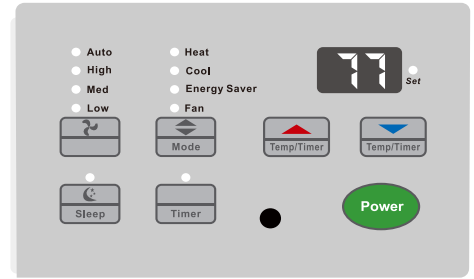

TO CHANGE
TEMPERATURE SETTING:

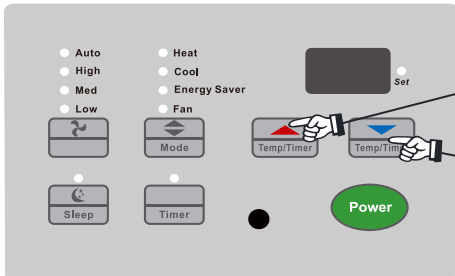

DO THIS:
PRESS TO RAISE
PRESS TO LOWER

YOU WILL SEE:

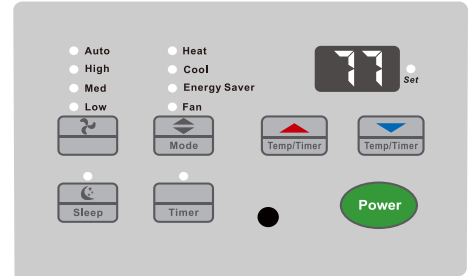

Note: Tap or hold either up(^) or down(v) button until the desired temperature is seen on display. This temperature will be automatically maintained anywhere between 61F (16° C) and 86F (30° C) for both cooling and heating modes. If you want the display to read the actual room temperature, "Select the fan only mode" .

TO CHANGE FAN SPEEDS:

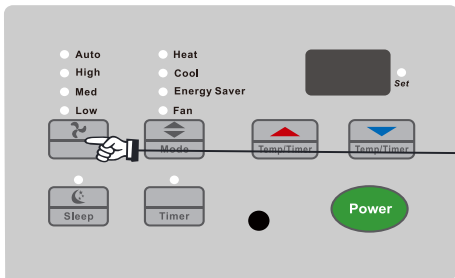

DO THIS:
PRESS FAN SPEED
BUTTON
SELECT SPEED

YOU WILL SEE THE
SPEED CHOSEN:

LIGHT ON

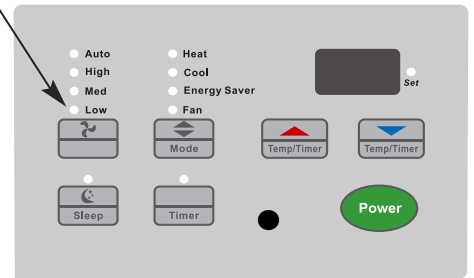

TO USE AUTO FAN FEATURE:

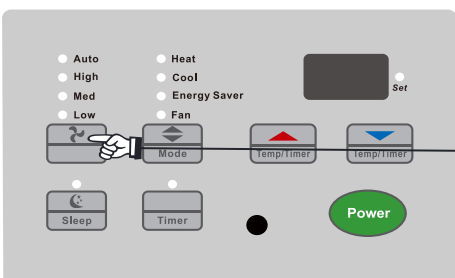

DO THIS:
PRESS FAN
SPEED BUTTON

SELECT
AUTO FAN

LIGHT ON

YOU WILL SEE:

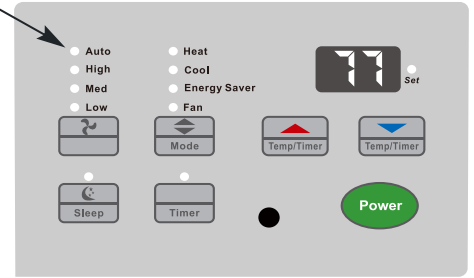

Note: The fan speed to automatically set to the speed needed to provide optimum comfort settings with the set temperature. If the room needs more cooling, the fan speed will automatically increase. If the room needs less cooling, the fan speed will automatically decrease. Auto fan speed cannot be used when in the Fan Only mode.

◆ Air Conditioner Features(continued)

TO OPERATE ON FAN ONLY:

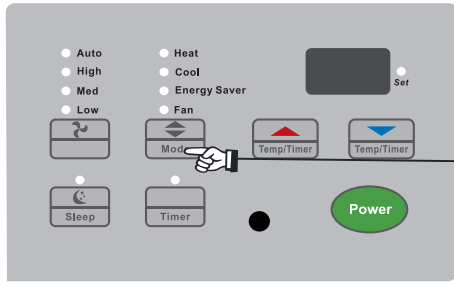

DO THIS:

PRESS
MODE BUTTON

CHOOSE
FAN ONLY

LIGHT ON

YOU WILL SEE:

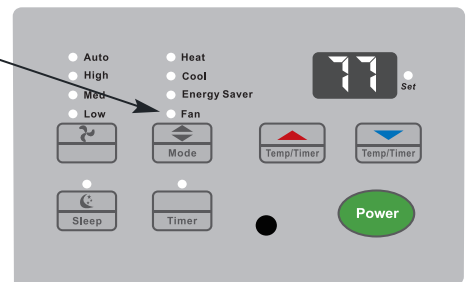

Note: Use this function only when cooling is not desired, such as for room air circulation. You can choose any fan speed you prefer, EXCEPT AUTO FAN. During this function, the display will show the actual current temperature, not the set temperature as in the cooling mode.

TO USE THE ENERGY SAVER FEATURE:

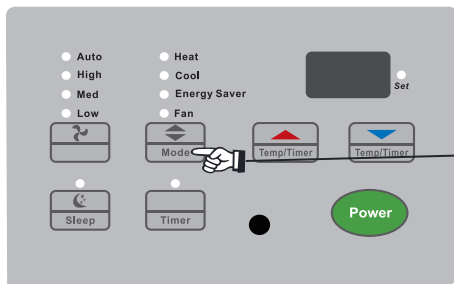

DO THIS:

PRESS
MODE BUTTON

CHOOSE
ENERGY SAVER

LIGHT ON

YOU WILL SEE:

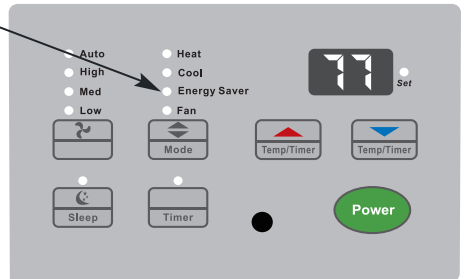

Note: In this mode, the fan will continue to run for a short time after the compressor cycles off.

TIMER-DELAY START/STOP FEATURE:

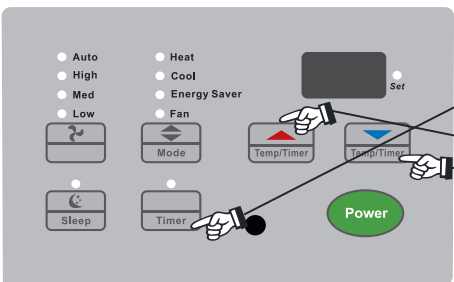

**FIRST
DO THIS:**

PRESS
TIMER
BUTTON

**THEN
DO THIS:**

PRESS
TEMP/TIMER
BUTTON

YOU WILL SEE THE TIME CHOSEN:

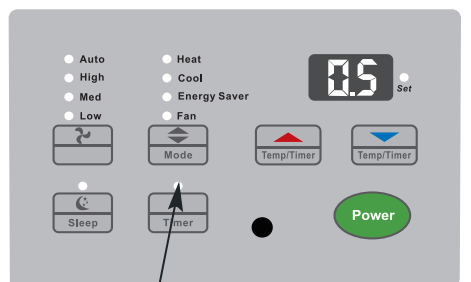

LIGHT ON

Note 1: For Delay Stop, the unit must be in the ON position.

Note 2: For Delay Start, the unit must be in the OFF position.

To adjust timer setting, tap or hold the UP arrow (^) or DOWN arrow (v) to change the delay time by 0.5 hour increments up to 10 hours, then by 1 hour increments up to 24 hours. The control will count down the timer remaining until start (8, 7.5, 7, etc.). After set Timer, the unit will enter into Timer mode by 5 seconds, then Timer light on, Set light off. In Timer mode: Set temperature and fan speed keeps previously set temperature and fan speed; Temperature display set temperature, no display if power turn off; Press Timer once, LED display remaining time of set time, LED return to set temperature by 5 seconds; When in Fan Only mode, LED only display room temperature, do not display set temperature. Turning the unit "ON" or "OFF" at any timer will cancel the Delay Start/Stop function. The delay Start/Stop feature will work until the unit either starts or stops. Once this has happened then the above steps have to be repeated again.

◆ Air Conditioner Features(continued)

HEATING FEATURE (on some models):

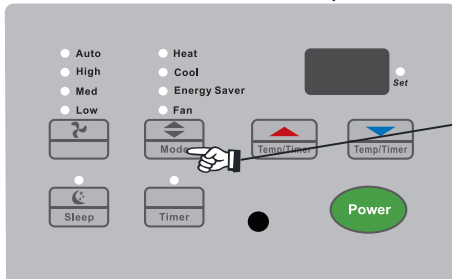

DO THIS:
PRESS
MODE BUTTON
SELECT HEAT

YOU WILL SEE:

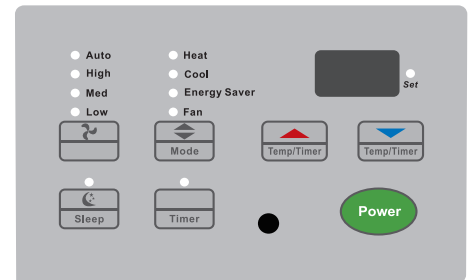

Note: This feature can be used with any combination of FAN Speeds, Timer, or Sleep Modes. When in the "Heat" Mode, the fan will run continuously while heat is needed. The temperature will automatically be maintained anywhere between 61°F (16°C) and 86°F (30°C). When the room set temperature is satisfied, the fan will cycle off and on to circulate and sample the room air.

SLEEP FEATURE :

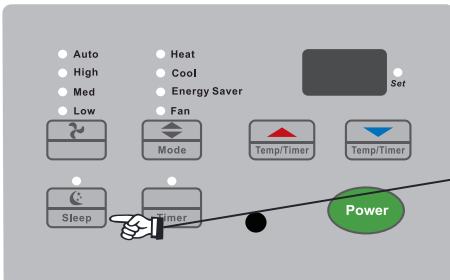

DO THIS:
PRESS
MODE BUTTON
SELECT SLEEP

YOU WILL SEE:

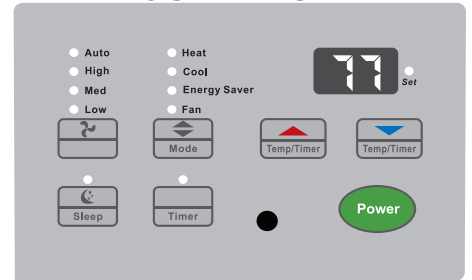

Note: Press this button, Sleep On and Sleep Off can be selected. After powered on, Sleep Off is defaulted. After the unit is turn off, the Sleep function is canceled. As the unit is in Cool or Energy Saver Modes, if Sleep Mode is set, SET TEMP. would increase 1°C in 1 hour and 2°C in 2 hours. As the unit is in Heat Mode, if Sleep Mode is set, SET TEMP. would decrease 1°C in 1 hour and 2°C in 2 hours. Under Fan Only and Auto modes, this function is not available.

TO TURN UNIT OFF:

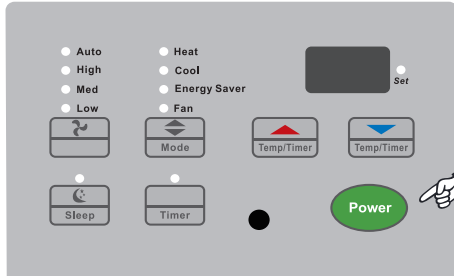

DO THIS:
PRESS
ON/OFF BUTTOT

YOU WILL SEE:

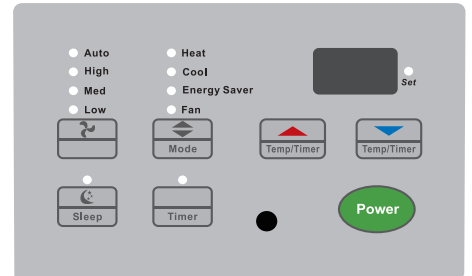

4-Way Directional Louvers

The 4-Way directional louvers allow you to direct the air up or down, left or right. Use the handle in the center of the louvers to change the air direction.

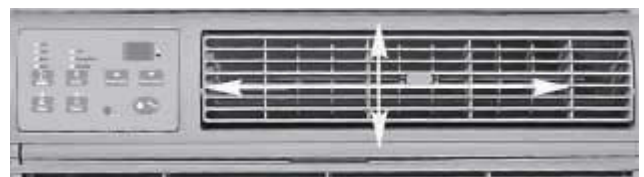

CARE AND CLEANING

Clean your air conditioner to keep it looking new and to minimize dust build up.

Air Filter Cleaning

The air filter should be checked at least once every month to see if it needs cleaning. Trapped particles and dust can build up in the filter and may decrease airflow as well as cause the cooling coils to accumulate frost. To clean the air filter:

1. Remove the filter by pulling down on the indent of the filter door on the front of the unit. (See FIG. 13)
2. Wash the filter using liquid dish soap and warm water. Rinse the filter thoroughly. Gently shake the filter to remove excess water.
3. Let the filter dry completely before placing it into the air conditioner.
4. If you do not wish to wash the filter, you may vacuum the filter to remove the dust and other particles.



FIG. 13

Wear and Tear

To minimize wear and tear on the air conditioner, always wait at least 3 minutes before changing modes. This will help prevent the compressor from overheating and the circuit breaker from tripping.

Winter Storage

To store the air conditioner when it is not in use for an extended period of time, remove it carefully from the window according to the installation instructions and cover it with plastic or place it in the original box.

Cabinet Cleaning

To clean the air conditioner cabinet:

- Unplug the air conditioner to prevent shock or a fire hazard. The cabinet and front panel of the air conditioner may be dusted with an oil-free cloth or washed with a cloth dampened in a solution of warm water and mild liquid soap. Rinse thoroughly with a damp cloth and wipe dry.
- Never use harsh cleaners, wax or polish on the cabinet front.
- Be sure to wring excess water from the cloth before wiping around the controls. Excess water in or around the controls may cause damage to the air conditioner.

Energy Saving Ideas

- Do not block the air flow inside with blinds, curtains or furniture; or outside with shrubs, enclosures, or other buildings.
- The capacity of the room air conditioner must fit the room size for efficient and satisfactory operation.
- Install the room air conditioner on the shady side of your home. A window that faces North is best because it receives the least amount of sun exposure.
- Close the fireplace damper, floor and wall registers so cool air does not escape.
- Keep blinds and drapes closed for cooling and open for heating.
- Clean the air filter as recommended in the "care and cleaning" section.
- Proper insulation and weather stripping in your home will help limit cool air loss.
- External house shading with trees, plants, or awnings helps reduce the air conditioner's work load.
- Operate heat producing appliances during the coolest part of the day. Such as a dishwasher, oven, or computer.

TROUBLESHOOTING

PROBLEM	POSSIBLE CAUSES	SOLUTIONS
The Air Conditioner will not start	The air conditioner is unplugged	<ul style="list-style-type: none"> • Make sure the air conditioner is plug is pushed completely into the outlet
	The fuse is blown/circuit breaker is tripped.	<ul style="list-style-type: none"> • Check the house fuse/circuit breaker box and replace the fuse or reset the breaker.
	Power Failure	<ul style="list-style-type: none"> • The unit will automatically re-start when power is restored. • There is a protective time delay (approx. 3 minutes) to prevent tripping of the compressor overload. For this reason, the unit may not start normal cooling for 3 minutes after it is turned back on.
	The current interrupter device is tripped.	<ul style="list-style-type: none"> • Press the RESET button located on the power cord plug. • If the RESET button will not stay engaged, discontinue use of the air conditioner and contact a qualified service technician.
The Air Conditioner does not cool as it should	Airflow is restricted	<ul style="list-style-type: none"> • Make sure there are no curtains, blinds, or furniture blocking the front of the air conditioner
	The temperature control may not be set correctly.	<ul style="list-style-type: none"> • Lower the set thermostat temperature
	The air filter is dirty	<ul style="list-style-type: none"> • Clean the filter. See the Cleaning and Care Section of the manual.
	The room may be too warm	<ul style="list-style-type: none"> • Please allow time for the room to cool down after turning on the air conditioner.
	Cold air is escaping	<ul style="list-style-type: none"> • Check for open furnace registers and cold air returns
	The Cooling Coils are frozen	<ul style="list-style-type: none"> • See "Air Conditioner Freezing Up" below.
The Air Conditioner is freezing up	Ice blocks the air flow and stops the air conditioner from cooling the room	<ul style="list-style-type: none"> • Set the MODE dial to HIGH FAN or HIGH COOL and set the thermostat to a higher temperature
The Remote Control is not working	The batteries are inserted incorrectly	<ul style="list-style-type: none"> • Check the position of the batteries.
	The batteries may be dead	<ul style="list-style-type: none"> • Replace the batteries

TROUBLESHOOTING (CONT.)

PROBLEM	POSSIBLE CAUSES	SOLUTIONS
Water is dripping outside	Hot and Humid weather.	<ul style="list-style-type: none"> • This is normal
Water is dripping inside the room	The air conditioner is not correctly tilted outside.	<ul style="list-style-type: none"> • For proper water drainage, make sure the air conditioner is slightly tilted downward from the front of the unit to the rear.
Water collects in the base pan	Moisture removed from the air is draining into the base pan.	<ul style="list-style-type: none"> • This is normal for a short period in areas with low humidity and normal for a longer period in areas with high humidity.
The Air Conditioner Display reads "F1"	A Sensor has failed in the air conditioner	<ul style="list-style-type: none"> • Contact customer service
The Air Conditioner Display reads "F2"	A Sensor has failed in the air conditioner	<ul style="list-style-type: none"> • Contact customer service
The Air Conditioner Display reads "F4"	A Sensor has failed in the air conditioner	<ul style="list-style-type: none"> • Contact customer service
The Air Conditioner Display reads "FJ"	A Sensor has failed in the air conditioner	<ul style="list-style-type: none"> • Contact customer service

Warranty

Soleus International Inc. warrants the accompanying Soleus Air Air Conditioner to be free of defects in material and workmanship for the applications specified in its operation instruction for the period of parts specified below.

5 YEARS FOR COMPRESSOR
1 YEAR FOR OTHER COMPONENTS

This warranty shall not apply to broken or marred cabinets, accessories, knobs, filters or routine maintenance. This warranty does not apply to uncrating, setup, installation, removal of the product for repair or reinstallation of the product after repair.

This warranty does not apply to repairs or replacements necessitated by any cause beyond the control of Soleus International including, but not limited to, any malfunction, defect or failure caused by or resulting from unauthorized service or parts, improper maintenance, operation contrary to furnished instructions, shipping or transit accidents, modification or repair by the user, abuse, misuse, neglect, accident, incorrect power line voltage, fire, flood or other Acts of God, or normal wear and tear.

Warranty service must be performed by a qualified HVAC contractor. Soleus maintains a centralized service network to provide parts and assist in resolving service problems if difficulties are encountered. Soleus agrees to provide service information, sell repair parts and reimburse the dealer /serviceman for parts in accordance with Soleus International's Policies and Procedures.

SOLEUS INTERNATIONAL MAINTAINS THAT ALL WARRANTIES, INCLUDING IMPLIED WARRANTY OR MERCHANTABILITY ARE LIMITED TO THE TERMS AND CONDITIONS SPECIFIED ABOVE. SOLEUS INTERNATIONAL DISCLAIMS ANY LIABILITY FOR CONSEQUENTIAL OR INCIDENTAL DAMAGES AND IN NO EVENT SHALL SOLEUS INTERNATIONAL INC.'S LIABILITY EXCEED THE RETAIL VALUE OF THE AIR CONDITIONER.

This warranty covers only new products purchased from our authorized dealers or retailers. It does not cover internet sales, used, salvaged, or refurbished products.

FOR TECHNICAL SUPPORT AND WARRANTY SERVICE, PLEASE CONTACT:

Soleus International Inc. 20035 E Walnut Dr North, City of Industry, CA 91789. USA

Tel: 1-888-8-SOLEUS Monday through Friday, 9:00 AM to 5:00 PM, PST

Email: Contact@soleusair.com

Website:

www.SoleusAir.com

www.SoleusHVAC.com

www.GreeUSA.com
